

Model F822S Through F834S Mulsifyre Directional Spray Nozzles, Open, with Strainers High Velocity

General Description

The Model F822S through F834S Mulsifyre Nozzles are open (nonautomatic) nozzles and they are designed for use in water spray fixed systems for fire protection applications where a high velocity water application may be required. The Mulsifiers are available in six different models that provide a wide range of orifice sizes and water distribution characteristics.

The Mulsifyre Nozzles are internal scroll type nozzles and they discharge a uniformly filled cone of relatively high velocity water droplets. Although the Mulsifyre Nozzles are designed primarily for use in fire extinguishment and control, they can also be used for exposure protection.

The Mulsifyre Nozzles are typically used in water spray fixed systems for the protection of special hazards such as:

- oil filled transformers and switching equipment,
- flammable liquid and gas storage tanks
- chemical process equipment,
- conveyor systems,
- openings in fire walls, and
- other equipment that is defined as hazardous due to the possibility of a rapidly spreading fire.

IMPORTANT

Refer to Technical Data Sheet TFP2300 for warnings pertaining to regulatory and health information.

Always refer to Technical Data Sheet TFP700 for the "INSTALLER WARNING" that provides cautions with respect to handling and installation of sprinkler systems and components. Improper handling and installation can permanently damage a sprinkler system or its components and cause the sprinkler to fail to operate in a fire situation or cause it to operate prematurely.

It is recommended that the end user be consulted with respect to the suitability of the materials of construction for any given corrosive environment. The effects of ambient temperature, concentration of chemicals, and gas/chemical velocity, should be considered, at a minimum, along with the corrosive nature to which the nozzles may be exposed.

NOTICE

The Model F822S through F834S Mulsifyre Nozzles described herein must be installed and maintained in compliance with this document, as well as with the applicable standards of the NATIONAL FIRE PROTECTION ASSOCIATION (NFPA), in addition to the standards of any other authorities having jurisdiction. Failure to do so may impair the performance of these devices.

The design of individual water spray fixed systems can vary considerably, depending on the characteristics and nature of the hazard, the basic purpose of the spraying system, the configuration of the hazard, and wind/draft conditions. Because of these variations as well as the wide range of available nozzle spray characteristics, the design of water spray fixed systems for fire protection must only be performed by experienced designers who thoroughly understand the limitations as well as capabilities of such systems.

The owner is responsible for maintaining their fire protection system and devices in proper operating condition. Contact the installing contractor or product manufacturer with any questions.

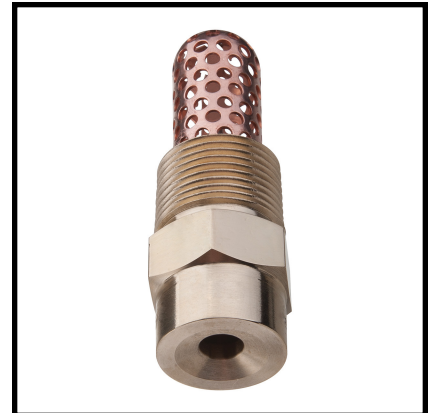

Technical Data

Approvals

FM Approved

Maximum Working Pressure

175 psi (12,1 bar)

See to Graph A, Note 2

Discharge Coefficient

See Figure 1

Water Distribution

Optimum flow pressure is 25 to 60 psi (1,7 to 4,1 bar); See Graph A (1 of 2).

Thread Connection

3/4 in. NPT

Physical Characteristics

Body	Brass
Scroll	Brass
Strainer	Brass

Model Number	Nominal Angle
F822S	80°
F824S	70°
F826S	125°
F828S	70°
F832S	90°
F834S	70°

TABLE A
NOMINAL SPRAY ANGLE
DATA

Design Criteria

Nozzle Placement

Where direct impingement of water spray onto all of the protected surface is required by the authority having jurisdiction, the nozzles are to be spaced and directed so that their spray patterns will completely cover the plane-of-protection with the minimum required average density. With reference to Graph A (1 of 2), use of the *Design Spray Profile* for the *Design Spray Area* will help assure that direct impingement on all surfaces will occur. The *Design Spray Area* shown at the top Graph A (2 of 2) consists of the square of length "S" within the circular *Overall Spray Area*.

The maximum recommended axial distances given in Graph A (2 of 2) are based on maintaining the specified spray patterns under a maximum wind condition of 15 MPH (24 km/h).

Individual strainers are required to comply with FM Approval.

Installation

The Model F822S through F834S Mulsifyre Nozzles must be installed in accordance with this section.

General Instructions

A leak tight 3/4 in. NPT nozzle joint should be obtained with a torque of 10 to 20 ft-lb (13,4 to 26,8 N-m). Higher levels of torque may distort the nozzle inlet and cause leakage or impairment of the nozzle.

Step 1. With pipe thread sealant applied to the pipe threads, hand tighten the nozzle into the nozzle fitting.

Step 2. Tighten the nozzle into the nozzle fitting using an adjustable crescent wrench. With reference to Figure 1 apply the adjustable crescent wrench to the nozzle wrench flats.

Model Number	K-factor		K-factor (ISO)		A Inches (mm)	B Inches (mm)	Color Code
	25-60 psi	61-175 psi	1,70-4,1 bar	4,2-12,0 bar			
	GPM/psi ^{1/2}	GPM/psi ^{1/2}	Lpm/bar ^{1/2}	Lpm/bar ^{1/2}			
F822S	2.0	1.9	28,8	27,4	3-1/8 (79,4)	1-5/16 (33,3)	Yellow
F824S	2.4	2.3 ^b	34,6	33,1	3-1/8 (79,4)	1-5/16 (33,3)	Red
F826S	2.6 ^a	2.5	37,4	36,0	3-1/8 (79,4)	1-5/16 (33,3)	Orange
F828S	2.7	2.5	38,9	36,0	3-1/4 (82,6)	1-3/8 (34,9)	White
F832S	4.6	4.2	66,2	60,5	3-3/8 (85,7)	1-1/2 (38,1)	Aluminum
F834S	4.7	4.2	67,7	60,5	4-5/16 (109,5)	2-7/16 (61,9)	Grey

Nominal range of K-factors is ± 5% except where noted:
a. Add ± 1%
b. Add ± 2%

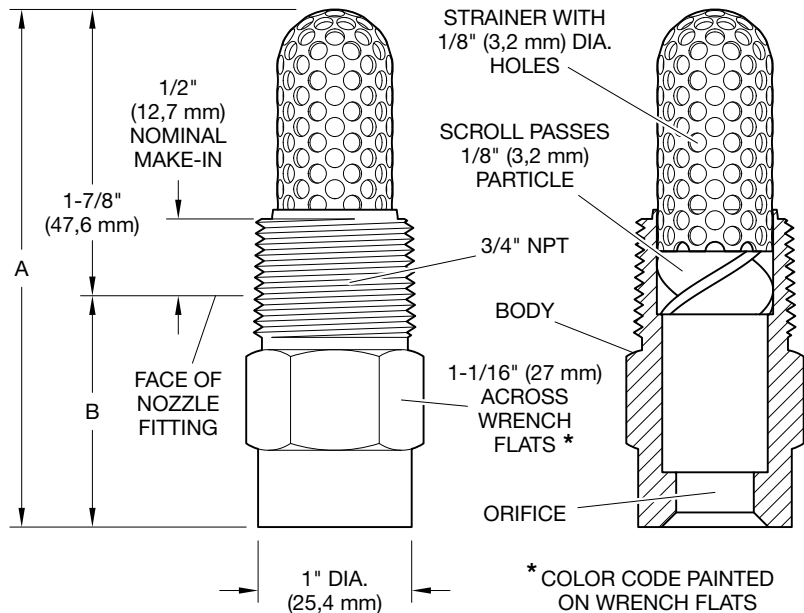
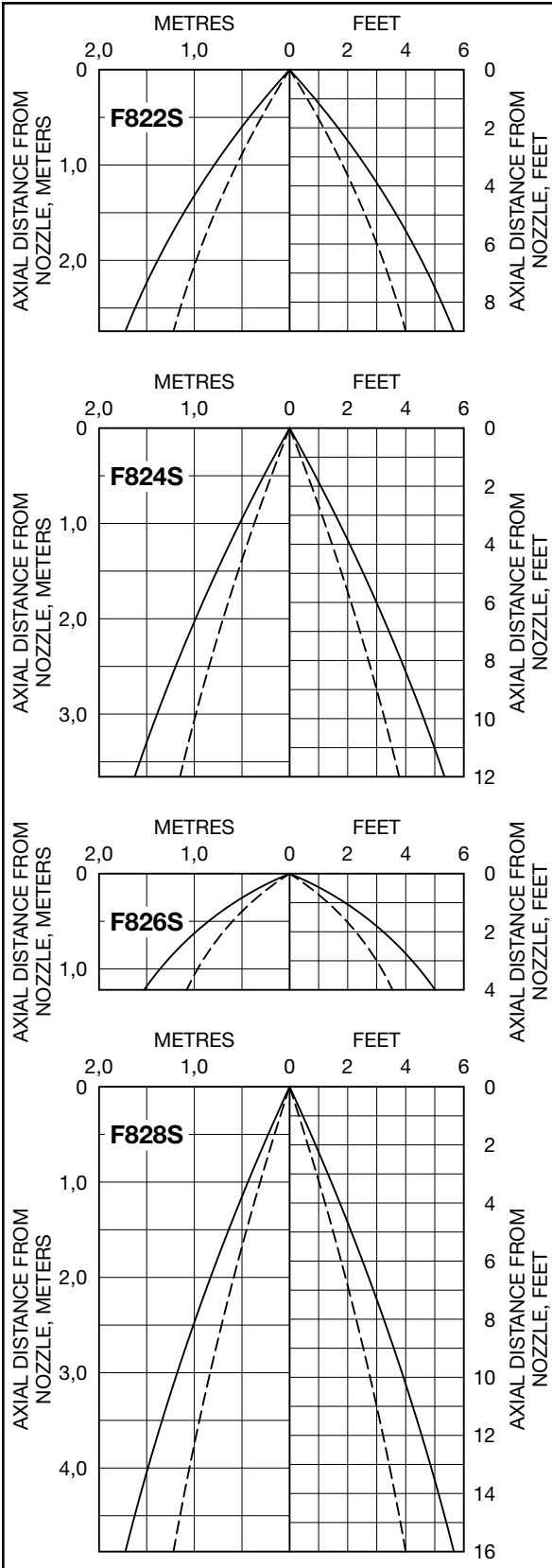
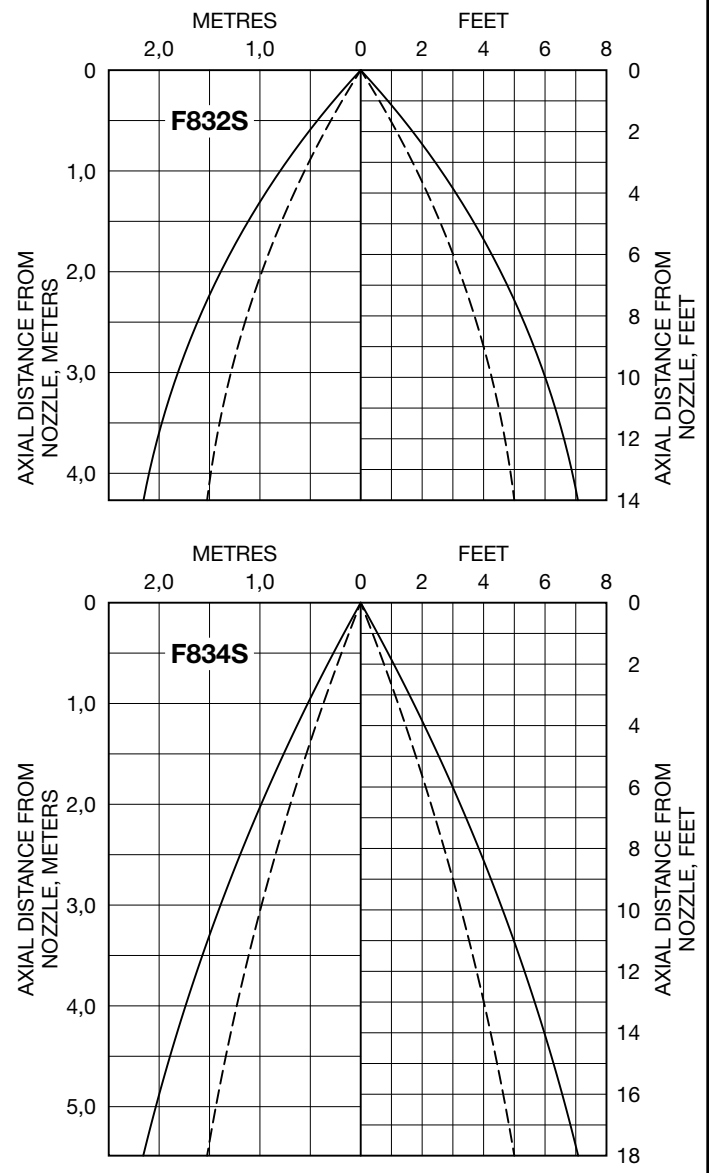
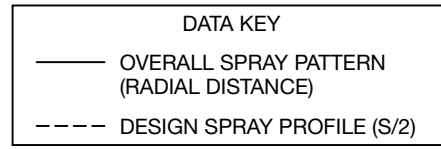

FIGURE 1
MODEL F822S THRU F834S MULSIFYRE NOZZLES
NOMINAL DIMENSIONS



NOTES:

1. Data applies to a maximum wind condition of 15 MPH (24 km/h).
2. Data applies to a residual (flowing) pressure range at the nozzle inlet of 25 to 60 psi (1,7 to 4,1 bar). (For pressures up to 175 psi (12,1 bar) consult Tyco Fire Protection Products Technical Services.)
3. The shapes of the Design Spray Profiles remain essentially unchanged over the maximum recommended axial distance and the residual (flowing) pressure range of 25 to 60 psi (1,7 to 4,1 bar).



GRAPH A (1 OF 2)
WATER DISTRIBUTION DESIGN DATA

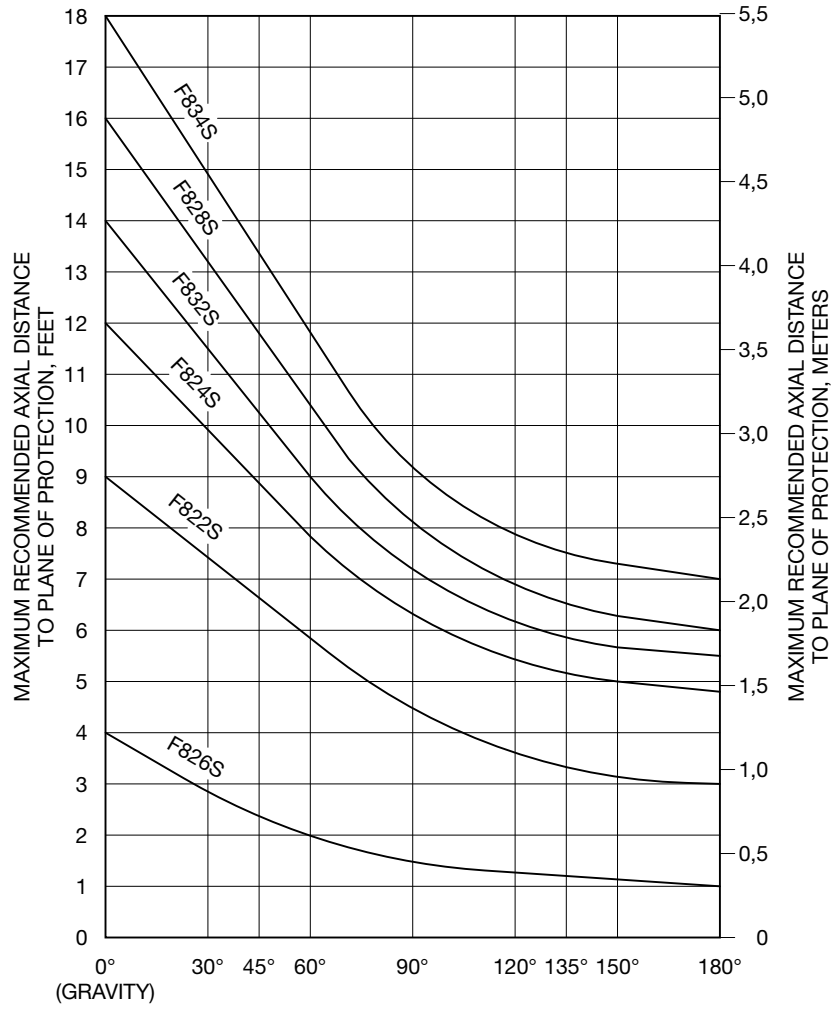
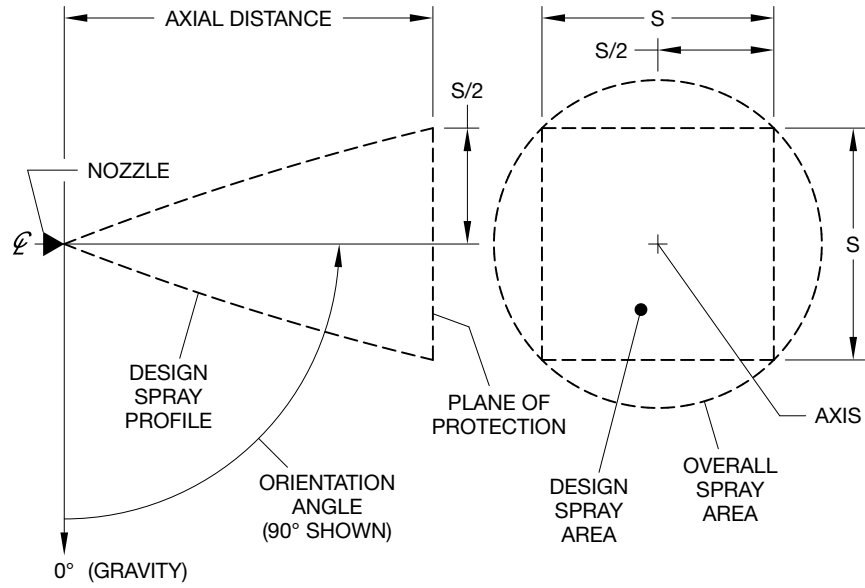

Care and Maintenance

The Model F822S through F834S Mulsifyre Nozzles must be maintained and serviced in accordance with this section.

Before closing a fire protection system main control valve for maintenance work on the fire protection system that it controls, permission to shut down the affected fire protection system must be obtained from the proper authorities and all personnel who may be affected by this action must be notified.

Mulsifyre Nozzles must never be painted, plated, coated or altered in any way after leaving the factory; otherwise, the spray performance may be impaired.

Care must be exercised to avoid damage to the nozzles before, during, and after installation. Nozzles damaged by dropping, striking, wrench twist/slip-page, or the like, must be replaced.

Frequent visual inspections are recommended to be initially performed for nozzles installed in potentially corrosive atmospheres to verify the integrity of the materials of construction as they may be affected by the corrosive conditions present for a given installation. Thereafter, annual inspections per NFPA 25 are required.

Water spray fixed systems for fire protection service require regularly scheduled care and maintenance by trained personnel. In addition to inspecting nozzles for proper spray performance during water flow trip tests of the system, it is recommended that nozzles be periodically inspected for broken or missing parts (including dust caps where applicable), loading/obstructions, or other evidence of impaired protection. The inspections should be scheduled weekly or as frequently as may be necessary, and corrective action must be taken to ensure that the nozzles will perform as intended in the event of a fire.

The owner is responsible for the inspection, testing, and maintenance of their fire protection system and devices in compliance with this document, as well as with the applicable standards of the NATIONAL FIRE PROTECTION ASSOCIATION such as NFPA 25, in addition to the standards of any other authorities having jurisdiction. Contact the installing contractor or product manufacturer with any questions.

It is recommended that water spray fixed systems be inspected, tested, and maintained by a qualified Inspection Service in accordance with local requirements and/or national codes.

Limited Warranty

For warranty terms and conditions, visit www.tyco-fire.com.

Ordering Procedure

Contact your local distributor for availability. When placing an order, indicate the full product name and P/N.

Mulsifyre Nozzles

Specify: Model (number) Mulsifyre Nozzle, P/N (specify):

Model F822S	49-810-1-822
Model F824S	49-810-1-824
Model F826S	49-810-1-826
Model F828S	49-810-1-828
Model F832S	49-810-1-832
Model F834S	49-810-1-834

